

# Arresters

IEEE & IEC Distribution Class

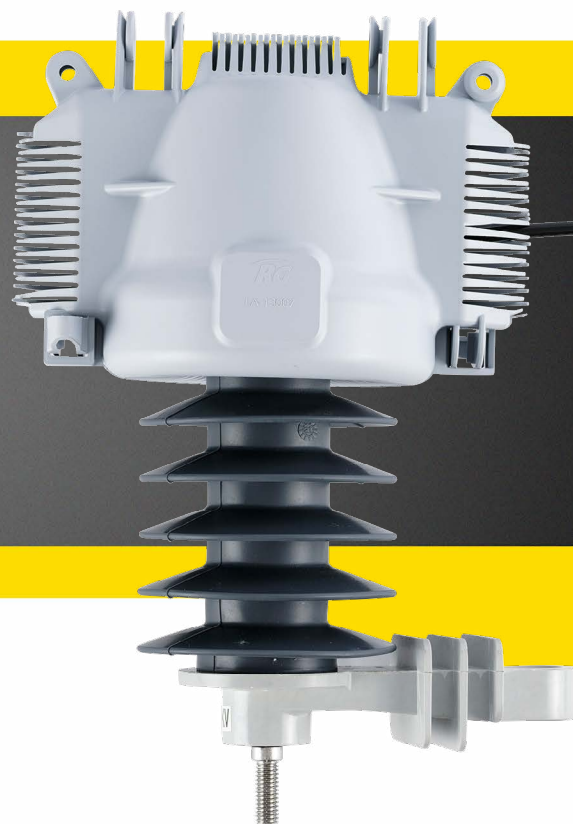

# Warranty

## Warranty – Material

HPS warrants to Buyer that the products sold will be free of defects in workmanship or material for a period of one (1) year (or as otherwise specified) from the date of original shipment by HPS when stored, installed, operated or maintained in accordance with recommendations of HPS and standard industry practice and when used under proper and normal use. HPS shall in no event be responsible or liable for modifications, alterations, misapplication or repairs made to its products by Buyer or others, or for damage caused thereto by negligence, accident or improper use by Buyer or others. This warranty does not include reimbursement for the expenses of labor, transportation, removal or reinstallation of the products. This warranty shall run only to the first Buyer of a product from HPS, from HPS' Buyer, or from an original equipment manufacturer reselling HPS' product, and is non-assignable and non-transferable and shall be of no force and effect if asserted by any person other than such first Buyer. THE FOREGOING WARRANTY IS EXCLUSIVE AND IN LIEU OF ALL OTHER WARRANTIES WHETHER WRITTEN, ORAL, EXPRESSED OR IMPLIED. THERE ARE NO WARRANTIES OF MERCHANTABILITY OR FITNESS OF ANY PRODUCT FOR A PARTICULAR PURPOSE.

## Warranty – Application

HPS does not warrant the accuracy of and results from product or system performance recommendations resulting from any engineering analysis or study. This applies regardless of whether a charge is made for the recommendation, or if it is provided free of charge. Responsibility for selection of the proper product of application rests solely with the Buyer. In the event of errors or inaccuracies determined to be caused by HPS, its liability will be limited to the re-performance of any such analysis or study.

## BUYER INSPECTIONS

Tests, inspections and acceptance of all material must be made at the factory. Buyer's inspectors are welcome at the factories and are provided with the necessary facilities for carrying out their work. Name and phone number of who should be contacted for inspection should be given to HPS no later than two weeks prior to scheduled shipment date.

## LIMITATION OF LIABILITY

IN NO EVENT AND UNDER NO CIRCUMSTANCES SHALL HPS BE LIABLE TO BUYER OR TO ANY OTHER PERSON FOR ANY INDIRECT, SPECIAL, CONSEQUENTIAL OR INCIDENTAL LOSSES OR DAMAGES, INCLUDING, WITHOUT LIMITATION, DAMAGE TO OR LOSS OF USE OF ANY PRODUCT, LOST SALES, OR PROFITS, OR DELAY OR FAILURE TO PERFORM THIS WARRANTY OBLIGATION, OR CLAIMS OF THIRD PARTIES AGAINST PURCHASER, ARISING OUT OF OR IN CONNECTION WITH THE SALE, INSTALLATION, USE OF, INABILITY TO USE, OR THE REPAIR OR REPLACEMENT OF, HPS' PRODUCTS. As stated herein, the term "person" shall include without limitation, any individual proprietorship, partnership, corporation or entity.

## EXCLUSIVE REMEDY

Any claim by Buyer that a product is defective or non-conforming shall be deemed waived by Buyer unless submitted to HPS in writing within thirty (30) days from the date Buyer discovered, or by reasonable inspection should have discovered the alleged defect or non-conformity. Any warranty claim must be brought within one year of discovery of the alleged defect or non-conformity. Upon prompt written notice by the Buyer that a product is defective or non-conforming, HPS' liability shall be limited to repairing or replacing the product, at HPS' option.

1850 Richland Avenue, East, Aiken, SC 29801

HubbellPowerSystems.com  
1.573.682.5521 o  
1.573.682.8714 f  
hpsliterature@hubbell.com

NOTE: Because Hubbell Power Systems Inc., has a policy of continuous product improvement, we reserve the right to change design and specifications without notice.

*Copyright 2020 Hubbell Power Systems Inc./Ohio Brass*



# IEEE and IEC Distribution Class Surge Arresters

INSIDE.....	PAGE
Overview .....	5
Arrester Selection Guidelines .....	6
<b>Products</b> .....	9
PDV-65 Optima, IEEE Normal Duty (ND)/IEC Distribution Medium (DM).....	9
PDV-100 Optima, IEEE Heavy Duty (HD)/IEC Distribution High (DH).....	10
PVR Optima, IEEE Heavy Duty (HD) Riser.....	11
PVI-LP, IEEE Intermediate/IEC Station Low (SL).....	12
Temporary Overvoltage Capability .....	14
Ground Lead Disconnecter .....	16
Insulating Base Brackets .....	17
Arrester Accessories .....	18
Arrester Hardware – Imperial.....	21
Arrester Hardware – Metric.....	22
Arrester Selection.....	23
Ordering .....	24
Routine Testing .....	25
Mechanical Capability.....	25
Arrester FAQ's.....	26
Technical Terms .....	28

reliability



# Over 70 years of Arrester Innovation



Ohio Brass introduced its first surge arresters more than a half-century ago. Since then, Hubbell Power Systems (HPS) and the Ohio Brass brand have led the industry in innovation, reliability and service.



During this time Hubbell introduced the world's first polymer-housed arresters, advanced MOV block technology, continued to pioneer polymer research and refined manufacturing processes. The company has obtained numerous patents for products and design features that have helped keep Hubbell arresters at the forefront of technology.



Since your customers' power is only as reliable as your delivery system, trust your lines, equipment, crews and reputation to Hubbell Power Systems surge arresters.

# solutions



# Overview

Hubbell introduced the first polymer housed surge arrester in 1986 and continues to be the market leader with a full line of polymer housed arresters for distribution voltages. The Hubbell distribution arrester portfolio includes IEEE Normal Duty (ND) and Heavy Duty (HD), as well as IEC Distribution Medium (DM) and Distribution High (DH) arrester products. An additional IEEE HD Riser pole arrester is available for cable protection or where enhanced protective capabilities are required. While not a true distribution arrester, an IEEE Intermediate and IEC Station Low (SL) arrester is available for crossarm or equipment mounted applications.

The Optima disconnecter is available for all Hubbell distribution arresters. The Optima design improves system reliability with the lowest current operating capability in the industry, while also increasing Temporary Overvoltage (TOV) capability. Additionally, its guaranteed to always operate so you can ensure a feeder will never be locked out due to an arrester.

As a market leader in arrester technology since 1950, Hubbell has a proven track record of continuing to advance arrester technology, distinguished product quality, and extraordinary customer support that establishes Hubbell as a premier manufacturer of arrester products.

## Basic Construction

Each PDV, PVR and PVI-LP arrester is constructed from a series of MOV (metal oxide varistor) blocks. The MOV blocks are manufactured by Hubbell in our state-of-the-art plant located in Ohio. Hubbell has over 40 years of experience and proven ability in manufacturing MOV blocks, and this in-house capability allows us to fully control the manufacturing and quality processes. MOV blocks dictate the performance characteristics of the arrester and are locked in place with tightly wound layers of fiberglass filament impregnated with epoxy resin.

The arrester housing is made from our proprietary blend of ESP™, an enhanced silicone polymer. In addition to ESP's exceptional performance as an insulator material, ESP's properties have been confirmed in a series of performance tests that include tracking resistance, contamination, aging, and seal design. The base arrester design boasts field experience dating back to 1986. No other manufacturer can match Hubbell's experience with distribution arresters.



The PDV, PVR and PVI-LP arresters can be used with a variety of mounting arms and brackets. They are also supplied with all the necessary fasteners, terminal attachments, and an integrated ground lead disconnecter (GLD). The GLD is comprised of a fiberglass-filled polyester insulating bracket, with integrated disconnecter. The disconnecter functions to remove a shorted arrester from the utility circuit. Additional brackets such as the cross arm or transformer bracket, enable mounting options that best suit every individual customer.

# Arrester Selection Guidelines

Hubbell manufactures a wide range of distribution class surge arresters to meet all user specific application requirements. All Hubbell surge arresters are qualified to the latest version of IEEE C62.11 or IEC 60099-4. Some Hubbell distribution class arresters are dually qualified to both IEEE and IEC standards. Light weight, easy to handle polymer arresters are exclusively used for all Hubbell distribution arrester applications. Our designs offer varying levels of electrical and mechanical capabilities to meet each client's specific needs. Hubbell surge arresters are installed in various environments across the world and continue to provide excellent equipment protection.

**Selecting the Right Arrester for Your Needs** – Selecting an appropriate arrester requires knowledge about your specific application. Main factors to consider include:

- Maximum system voltage
- System grounding practices (effectively grounded, impedance grounded, ungrounded)
- Levels and durations of power frequency overvoltages
- Insulation level of equipment to be protected
- Mechanical loads that arrester will be subjected to
- Available line-to-ground fault current
- Fault clearing time
- Any unique environmental conditions

**Standard operating conditions for a.c. surge arresters are identified in IEC 60099-4 and IEEE C62.11, including:**

- Nominal power system frequency of 48 to 62 Hz
- Altitude of 3281 ft (1000 m)
- Ambient air temperature in the general vicinity of the arrester between -40 °C and 40 °C
- Wind speeds  $\leq$  111 ft/s (34 m/s)

Surge arrester applications and the associated service conditions are vast and wide ranging. Exposure to conditions outside of these limits will require special consideration in the design and application of surge arresters. Arresters can be exposed to high levels of contamination, sub-zero temperatures, hurricane force winds, wildlife interference and other varying conditions. Ensuring the arrester is selected, configured and installed properly to successfully survive these conditions is key to ensuring arrester longevity and protection of your valuable assets.

\* For applications outside the usual service conditions, or any other application related question, please contact your Hubbell Power Systems Representative at 1.573.682.5521.



# Arrester Selection Guidelines

## Arrester Types

Hubbell offers both IEEE and IEC compliant distribution arrester products. The application may dictate the use of a different design to handle excessive lightning duty, high TOV or offer superior equipment protection. Distribution arresters are commonly applied on system voltages from 3 – 46 kV. Use this guide to help select the correct arrester classification for your specific application. Other designs are available for unique applications. Please contact Hubbell for additional support in the selection process.

Product Line	IEEE Class	IEC Class	MCOV (kV rms)	Duty Cycle Rating (kV rms)	Housing Material	Thermal Charge Rating, Qth (C)	Repetitive Charge Transfer Rating, Qrs (C)	Rated Short Circuit Current (kA rms)
PDV-65 Optima	Normal Duty	Distribution Medium	2.55 - 29	3 - 36	ESP™ Polymer	0.7	0.2	16
PDV-100 Optima	Heavy Duty	Distribution High	2.55 - 34	3 - 42	ESP™ Polymer	1.1	0.4	20
PVR Optima	Heavy Duty Riser	-	2.55 - 29	3 - 36	ESP™ Polymer	-	0.5	20
PVI-LP	Intermediate	Station Low	2.55 - 57	3 - 72	ESP™ Polymer	-	2.0	40



All Hubbell PDV, PVR and PVI-LP arresters feature the same high quality MOV blocks that have been manufactured in our state-of-the-art facility since 1977. Our long history with MOV technology ensures the MOV blocks used in all Hubbell arresters meet not only industry standards, but also Hubbell exacting requirements.

Our proprietary ESP™ weathershed material, made of a blend of silicone and EPDM, resists tracking and provides exceptional leakage distance. It has proven its mettle in some of the toughest weather conditions for decades.

These features protect system equipment, service reliability, your lineman and your bottom line.

# Arrester Selection Guidelines

Selecting the appropriate MCOV (Uc for IEC arresters) of a surge arrester is a critical step in the protection of vital utility equipment. The MCOV of an arrester should be selected to ensure it can withstand the maximum continuous line to ground voltage. The table below provides general guidelines for solidly grounded applications, as well as impedance or undergrounded circuits. A higher or lower rated arrester may be required depending on the exact application.

System Voltage (kV)		Arrester MCOV or Uc (kV)	
Nominal	Maximum	Effectively Grounded Neutral Circuit	Impedance Grounded & Ungrounded Circuits
2.40	2.52	2.55	2.55
4.16	4.37	2.55	5.1
4.80	5.08	5.1	5.1
6.90	7.25	5.1	7.65
8.32	8.74	5.1	10.2
11.0	12.0	7.65	12.7
12.0	12.6	7.65	12.7
12.5	13.1	7.65	15.3
13.2	13.9	8.4	15.3
13.8	14.5	8.4	15.3
20.8	21.8	12.7	22
22.9	24.0	15.3	24.4
23.0	24.2	15.3	24.4
24.9	26.2	15.3	29
27.6	29.0	17	29
34.5	36.2	22	39
46.0	48.3	29	57



The actual MCOV of each arrester will be determined according to the exact system parameters. Smaller or higher rated arresters may be required based on system fault durations and the associated overvoltage magnitude. Arrester selection is additionally dictated by the insulation being protected. Depending on the equipment being protected it's recommended to have 15 or 20% protective margin, as a minimum. Additional lead length in the circuit can negatively impact the protective margin in each application. Please consult with Hubbell for additional support to select the appropriate MCOV for your specific arrester application.



# PDV-65 Optima

PDV-65 Optima arresters meet the Normal Duty requirements of IEEE C62.11 and the Distribution Medium requirements of IEC 60099-4. This arrester class is suitable for withstanding a 65 kA high current impulse. An option is available for both Imperial and Metric hardware.

## Electrical Characteristics

Base Imperial Catalog Number	Base Metric Catalog Number	MCOV (kV)	Duty Cycle Rating, Ur (kV)	Temporary overvoltage capability (kV) No prior duty		Max steep current impulse residual voltage (kV)	Max Switching impulse residual voltage (kV)	Max lightning impulse residual voltage (kV)					
				1 s	10 s	5 kA	0.5 kA	1.5 kA	3 kA	5 kA	10 kA	20 kA	40 kA
217253	294003	2.55	3	3.8	3.6	10.1	7.3	8.1	8.7	9.2	10.4	12.0	15.0
217255	294005	5.1	6	7.6	7.2	20.2	14.6	16.3	17.3	18.5	20.8	24.0	30.0
217258	294008	7.65	9	11.4	10.9	29.3	21.1	23.6	25.1	26.8	30.2	34.9	43.6
217259	294009	8.4	10	12.5	11.9	32.6	23.5	26.3	28.0	29.8	33.6	38.8	48.5
217560	294010	10.2	12	15.2	14.5	39.1	28.1	31.5	33.5	35.7	40.2	46.5	58.1
213263	294013	12.7	15	18.9	18.0	49.6	35.7	39.9	42.5	45.3	51.0	58.9	73.7
213265	294015	15.3	18	22.8	21.7	58.7	42.2	47.2	50.3	53.6	60.3	69.7	87.1
213267	294017	17	21	25.3	24.1	66.1	47.5	53.2	56.6	60.3	67.9	78.5	98.1
217570	294020	19.5	24	29.1	27.7	78.2	56.3	62.9	67.0	71.4	80.4	92.9	116.2
213272	294022	22	27	32.8	31.2	88.0	63.3	70.8	75.4	80.4	90.5	104.6	130.7
213274	294024	24.4	30	36.4	34.6	97.8	70.4	78.7	83.8	89.3	100.6	116.2	145.2
213279	294029	29	36	43.2	41.2	117.4	84.5	94.4	100.5	107.2	120.7	139.4	174.3

## Physical Characteristics

Base Imperial Catalog Number	Base Metric Catalog Number	MCOV	Duty Cycle Rating, Ur	Arrester Only Height	Creepage Distance	Strike Distance with Bracket	Recommended Clearances - Inches (mm)		Arrester Only Weight	Lightning Withstand Voltage	Power Frequency Withstand Voltage - Wet
		kV	kV	Inches (mm)	Inches (mm)	Inches (mm)	Phase-Phase	Phase-Ground	Pounds (kg)	kVpk	kVpk
217253	294003	2.55	3	4.9(124)	13.3(338)	7.3(185)	5.0 (127)	3.0 (76)	1.7(0.8)	115	60
217255	294005	5.1	6	4.9(124)	13.3(338)	7.3(185)	5.4 (137)	3.4 (86)	1.7(0.8)	115	60
217258	294008	7.65	9	4.9(124)	13.3(338)	7.3(185)	6.0 (152)	4.0 (102)	1.7(0.8)	115	60
217259	294009	8.4	10	4.9(124)	13.3(338)	7.3(185)	6.2 (157)	4.2 (107)	1.7(0.8)	115	60
217560	294010	10.2	12	5.5 (140)	15.4 (390)	7.9 (200)	7.5 (191)	5.5 (140)	1.9 (0.9)	120	65
213263	294013	12.7	15	8.0(203)	23.3(592)	10.2(260)	8.5 (216)	6.5 (165)	2.3(1.0)	160	85
213265	294015	15.3	18	8.0(203)	23.3(592)	10.2(260)	9.5 (241)	7.5 (191)	2.3(1.0)	160	85
213267	294017	17	21	8.5 (216)	25.4 (645)	11.4 (290)	10.0 (254)	8.0 (203)	2.6 (1.2)	175	90
217570	294020	19.5	24	10.9 (277)	30.7 (780)	13.0 (330)	12.0 (305)	10.0 (254)	3.0 (1.4)	195	110
213272	294022	22	27	12.8(325)	36.6(930)	15.7(400)	13.0 (330)	11.0 (279)	3.1 (1.4)	225	120
213274	294024	24.4	30	13.5(343)	38.7(983)	15.7(400)	14.0 (356)	12.0 (305)	3.3(1.5)	230	125
213279	294029	29	36	15.9(404)	46.6(1184)	18.1(460)	16.5 (419)	14.5 (368)	3.6(1.7)	240	140

# PDV-100 Optima

PDV-100 Optima arresters meet the Heavy Duty requirements of IEEE C62.11 and the Distribution High requirements of IEC 60099-4. This arrester class is suitable for withstanding a 100 kA high current impulse. An option is available for both Imperial and Metric hardware.

## Electrical Characteristics

Base Imperial Catalog Number	Base Metric Catalog Number	MCOV (kV)	Duty Cycle Rating, Ur (kV)	Temporary overvoltage capability (kV)		Max steep current impulse residual voltage (kV)	Max switching impulse residual voltage (kV)	Max lightning impulse residual voltage (kV)					
				No prior duty				10 kA	0.5 kA	1.5 kA	3 kA	5 kA	10 kA
				1 s	10 s								
213703	294203	2.55	3	3.9	3.7	11.5	7.3	8.0	8.6	9.1	9.9	11.2	13.3
213705	294205	5.1	6	7.8	7.4	22.4	14.7	16.0	17.1	18.2	19.8	22.5	26.5
213708	294208	7.65	9	11.7	11.1	32.7	21.5	23.5	25.1	26.6	29.0	32.9	38.8
213709	294209	8.4	10	12.9	12.2	35.5	23.4	25.6	27.4	29.0	31.6	35.9	42.3
213710	294210	10.2	12	15.6	14.8	42.1	27.8	30.4	32.6	34.5	37.6	42.7	50.3
213713	294213	12.7	15	19.5	18.4	53.8	35.4	38.7	41.4	43.8	47.8	54.3	64.0
213715	294215	15.3	18	23.5	22.2	63.1	41.7	45.6	48.8	51.7	56.4	64.1	75.5
213717	294217	17	21	26.1	24.7	71.0	47.0	51.4	55.0	58.2	63.5	72.1	85.0
213720	294220	19.5	24	29.9	28.3	85.5	56.4	61.6	66.0	69.9	76.2	86.6	102.0
213722	294222	22	27	33.7	31.9	95.9	63.3	69.2	74.0	78.4	85.5	97.1	114.5
213724	294224	24.4	30	37.4	35.4	105.2	69.6	76.0	81.4	86.2	94.0	106.8	125.9
213729	294229	29	36	44.5	42.1	126.3	83.5	91.3	97.8	103.5	112.9	128.3	151.2
213731	294231	31.5	39	48.3	45.7	134.2	88.8	97.1	103.9	110.0	120.0	136.3	160.7
213734	294234	34	42	52.1	49.3	142.0	94.0	102.7	110.0	116.5	127.0	144.3	170.1

## Physical Characteristics

Base Imperial Catalog Number	Base Metric Catalog Number	MCOV	Duty Cycle Rating, Ur	Arrester Only Height	Creepage Distance	Strike Distance with Bracket	Recommended Clearances - Inches (mm)		Arrester Only Weight	Lightning Withstand Voltage	Power Frequency Withstand Voltage - Wet
		kV	kV	Inches (mm)	Inches (mm)	Inches (mm)	Phase-Phase	Phase-Ground	Pounds (kg)	kVpk	kVpk
213703	294203	2.55	3	3.0 (76)	8.5 (216)	5.6 (141)	5.0 (127)	3.0 (76)	2.2 (1.0)	85	25
213705	294205	5.1	6	3.8 (97)	11.3 (287)	6.3 (161)	5.4 (137)	3.4 (86)	2.5 (1.1)	100	35
213708	294208	7.65	9	4.9 (124)	14.4 (366)	7.5 (190)	6.0 (152)	4.0 (102)	3.1 (1.4)	120	41
213709	294209	8.4	10	4.9 (124)	14.4 (366)	7.5 (190)	6.2 (157)	4.2 (107)	3.1 (1.4)	120	41
213710	294210	10.2	12	5.5 (140)	17.0 (432)	8.3 (212)	7.5 (191)	5.5 (140)	3.4 (1.5)	125	45
213713	294213	12.7	15	7.8 (198)	25.2 (640)	10.6 (268)	8.5 (216)	6.5 (165)	4.6 (2.1)	155	58
213715	294215	15.3	18	7.8 (198)	25.2 (640)	10.6 (268)	9.5 (241)	7.5 (191)	4.6 (2.1)	155	58
213717	294217	17	21	8.6 (218)	28.1 (714)	11.5 (291)	10.0 (254)	8.0 (203)	5.0 (2.3)	170	71
213720	294220	19.5	24	11.5 (292)	36.5 (927)	14.2 (360)	12.0 (305)	10.0 (254)	6.3 (2.9)	210	85
213722	294222	22	27	12.6 (320)	39.6 (1006)	15.2 (385)	13.0 (330)	11.0 (279)	6.8 (3.1)	230	89
213724	294224	24.4	30	13.1 (333)	42.2 (1072)	15.7 (400)	14.0 (356)	12.0 (305)	7.1 (3.2)	240	92
213729	294229	29	36	15.5 (394)	50.4 (1280)	18.0 (456)	16.5 (419)	14.5 (368)	8.6 (3.9)	260	102
213731	294231	31.5	39	16.3 (414)	53.5 (1360)	18.5 (470)	17.8 (453)	15.5 (394)	8.9 (4.0)	270	106
213734	294234	34	42	17.2 (437)	56.2 (1428)	19.6 (500)	19.2 (488)	16.7 (425)	9.1 (4.1)	280	112



# PVR Optima

PVR Optima arresters are suitable for Riser pole applications. While Riser is not a distinct IEEE or IEC class of arrester, the PVR Optima design meets the Heavy Duty requirements of IEEE C62.11. This arrester offers an enhanced protective capability when compared to the PDV-100 Optima. This arrester class is suitable for withstanding a 100 kA high current impulse. An option is only available for Imperial hardware.

## Electrical Characteristics

Base Imperial Catalog Number	MCOV (kV)	Duty Cycle Rating (kV)	Temporary overvoltage capability (kV) No prior duty		Max steep current impulse residual voltage (kV) 10 kA	Max switching impulse residual voltage (kV) 0.5 kA	Max lightning impulse residual voltage (kV)					
			1 s	10 s			1.5 kA	3 kA	5 kA	10 kA	20 kA	40 kA
			221603	2.55			3	3.7	3.5	10.5	6.7	7.8
221605	5.1	6	7.4	7.0	21.0	13.5	15.6	16.3	17.0	18.3	20.2	23.4
221608	7.65	9	11.1	10.5	27.6	18.0	20.9	21.8	22.7	24.5	27.1	31.4
221609	8.4	10	12.2	11.5	30.3	19.9	23.1	24.1	25.1	27.0	29.8	34.6
221610	10.2	12	14.8	14.0	36.2	23.9	27.8	29.0	30.2	32.5	35.9	41.6
221613	12.7	15	18.4	17.4	45.5	29.8	34.6	36.1	37.6	40.5	44.8	51.8
221615	15.3	18	22.2	21.0	54.5	36.0	41.8	43.6	45.4	48.9	54.0	62.6
221617	17	21	24.7	23.3	61.7	40.9	47.5	49.5	51.6	55.6	61.4	71.2
221620	19.5	24	28.3	26.8	72.2	47.8	55.5	57.8	60.2	64.9	71.7	83.1
221622	22	27	31.9	30.2	81.4	53.0	61.6	64.2	66.8	72.0	79.6	92.2
221624	24.4	30	35.4	33.5	91.0	59.6	69.3	72.2	75.2	81.0	89.5	103.7
221629	29	36	42.1	39.8	107.2	70.7	82.2	85.6	89.2	96.1	106.2	123.0

## Physical Characteristics

Base Imperial Catalog Number	MCOV	Duty Cycle Rating, Ur	Arrester Only Height	Creepage Distance	Strike Distance with Bracket	Recommended Clearances - Inches (mm)		Arrester Only Weight	Lightning Withstand Voltage	Power Frequency Withstand Voltage - Wet
	kV	kV	Inches (mm)	Inches (mm)	Inches (mm)	Phase-Phase	Phase-Ground	Pounds (kg)	kVpk	kVpk
221603	2.55	3	3.1 (79)	8.0 (203)	3.6 (92)	5.0 (127)	3.0 (76)	1.7 (0.8)	50	20
221605	5.1	6	5.5 (140)	15.4 (391)	6.8 (173)	5.3 (135)	3.3 (84)	4 (1.8)	105	40
221608	7.65	9	5.5 (140)	15.4 (391)	6.8 (173)	5.8 (147)	3.8 (97)	2 (0.9)	105	40
221609	8.4	10	5.5 (140)	15.4 (391)	6.8 (173)	6.0 (152)	4.0 (102)	2 (0.9)	105	40
221610	10.2	12	5.5 (140)	15.4 (391)	6.8 (173)	7.3 (185)	5.3 (135)	2 (0.9)	105	40
221613	12.7	15	8.5 (216)	26.0 (660)	10.4 (264)	8.3 (211)	6.3 (160)	2.8 (1.3)	150	60
221615	15.3	18	8.5 (216)	26.0 (660)	10.4 (264)	9.2 (234)	7.2 (183)	2.8 (1.3)	150	60
221617	17	21	8.5 (216)	26.0 (660)	10.4 (264)	9.7 (246)	7.7 (196)	2.8 (1.3)	150	60
221620	19.5	24	10.9 (277)	30.8 (782)	12.0 (305)	11.6 (295)	9.6 (244)	3.0 (1.4)	165	70
221622	22	27	17.2 (437)	52.0 (1321)	18.7 (475)	12.5 (318)	10.5 (267)	4.6 (2.1)	270	105
221624	24.4	30	17.2 (437)	52.0 (1321)	18.7 (475)	13.5 (343)	11.5 (292)	4.6 (2.1)	270	105
221629	29	36	17.2 (437)	52.0 (1321)	18.7 (475)	16.0 (406)	14.0 (356)	4.6 (2.1)	270	105

# PVI-LP

PVI-LP arresters meet the Intermediate requirements of IEEE C62.11 and the Station Low requirements of IEC 60099-4. While not a true distribution class arrester, this design is suitable for equipment protection or enhanced protective capability on distribution lines. An option is available for both Imperial and Metric hardware.

## Electrical Characteristics

Base Imperial Catalog Number	Base Metric Catalog Number	MCOV (kV)	Duty Cycle Rating, Ur (kV)	Temporary overvoltage capability (kV) No prior duty		Max steep current impulse residual voltage (kV)	Max switching impulse residual voltage (kV)	Max lightning impulse residual voltage (kV)					
				1 s	10 s			10 kA	0.5 kA	1.5 kA	3 kA	5 kA	10 kA
218403	214503	2.55	3	3.6	3.4	10.7	6.6	7.1	7.4	7.8	8.1	9.1	10.2
218405	214505	5.1	6	7.1	6.8	19.6	13.1	14.1	14.8	15.5	16.2	18.2	20.4
218408	214508	7.65	9	10.7	10.3	28.6	19.7	21.3	22.3	23.4	24.4	27.4	30.8
218409	214509	8.4	10	11.8	11.3	31.4	21.8	23.4	24.6	25.8	26.9	30.2	33.9
218410	214510	10.2	12	14.3	13.7	37.3	26.1	28.1	29.5	30.9	32.3	36.3	40.7
218413	214513	12.7	15	17.8	17.0	47.8	32.8	35.4	37.1	38.9	40.6	45.6	51.2
218415	214515	15.3	18	21.4	20.5	56.9	39.5	42.5	44.6	46.8	48.8	54.8	61.5
218417	214517	17	21	23.8	22.8	62.4	43.5	46.9	49.2	51.5	53.8	60.4	67.8
218420	214520	19.5	24	27.3	26.1	74.3	52.3	56.3	59.0	61.9	64.6	72.5	81.5
218422	214522	22	27	30.8	29.5	85.1	59.2	63.8	66.9	70.1	73.2	82.2	92.3
218424	214524	24.4	30	34.2	32.7	93.4	65.3	70.3	73.8	77.3	80.7	90.6	101.8
218429	214529	29	36	40.6	38.9	111.3	78.4	84.4	88.6	92.8	96.9	108.8	122.2
218431	214531	31.5	39	44.1	42.2	118.9	83.0	89.4	93.8	98.3	103.0	115.2	129.4
218436	214536	36.5	45	51.1	48.9	136.0	95.8	103.0	108.0	113.4	118.0	133.0	149.3
218439	214539	39	48	54.6	52.3	148.0	105.0	113.0	118.0	123.8	129.0	145.0	162.9
218442	214542	42	54	58.8	56.3	161.0	113.0	122.0	128.0	134.0	140.0	157.0	176.4
218448	214548	48	60	67.2	64.3	179.0	126.0	136.0	143.0	149.5	156.0	175.0	196.8
218457	214557	57	72	79.8	76.4	216.0	152.0	164.0	172.0	180.5	188.0	212.0	237.6



## Physical Characteristics

Base Imperial Catalog Number	Base Metric Catalog Number	MCOV	Duty Cycle Rating, Ur	Arrester Only Height	Creepage Distance	Strike Distance with Bracket	Recommended Clearances - Inches (mm)		Arrester Only Weight	Lightning Withstand Voltage	Power Frequency Withstand Voltage - Wet
		kV	kV	Inches (mm)	Inches (mm)	Inches (mm)	Phase-Phase	Phase-Ground	Pounds (kg)	kVpk	kVpk
218403	214503	2.55	3	5.5 (140)	15.4 (391)	5.6 (142)	4.4 (112)	3.3 (84)	4.6 (2.1)	110	52
218405	214505	5.1	6	5.5 (140)	15.4 (391)	5.6 (142)	4.6 (117)	3.3 (84)	4.6 (2.1)	110	52
218408	214508	7.65	9	5.5 (140)	15.4 (391)	5.6 (142)	4.7 (119)	3.3 (84)	4.6 (2.1)	110	52
218409	214509	8.4	10	5.5 (140)	15.4 (391)	5.6 (142)	4.9 (124)	3.5 (89)	4.6 (2.1)	110	52
218410	214510	10.2	12	5.5 (140)	15.4 (391)	5.6 (142)	4.9 (124)	3.5 (89)	4.6 (2.1)	110	52
218413	214513	12.7	15	10.9 (276)	30.8 (782)	10.8 (274)	6.2 (157)	4.8 (122)	8.4 (3.8)	175	105
218415	214515	15.3	18	10.9 (276)	30.8 (782)	10.8 (274)	6.6 (168)	5.2 (132)	8.4 (3.8)	175	105
218417	214517	17	21	10.9 (276)	30.8 (782)	10.8 (274)	7.6 (193)	6.2 (157)	8.4 (3.8)	175	105
218420	214520	19.5	24	10.9 (276)	30.8 (782)	10.8 (274)	7.6 (193)	6.2 (157)	8.4 (3.8)	175	105
218422	214522	22	27	16.3 (415)	46.2 (1173)	16.1 (408)	9.6 (244)	8.2 (208)	12.3 (5.6)	204	134
218424	214524	24.4	30	16.3 (415)	46.2 (1173)	16.1 (408)	9.8 (249)	8.4 (213)	12.3 (5.6)	204	134
218429	214529	29	36	16.3 (415)	46.2 (1173)	16.1 (408)	9.8 (249)	8.4 (213)	12.3 (5.6)	204	134
218431	214531	31.5	39	21.7 (551)	61.6 (1564)	21.3 (541)	12.8 (325)	11.4 (290)	18.5 (8.4)	260	180
218436	214536	36.5	45	21.7 (551)	61.6 (1564)	21.3 (541)	12.8 (325)	11.4 (290)	18.5 (8.4)	260	180
218439	214539	39	48	21.7 (551)	61.6 (1564)	21.3 (541)	12.8 (325)	11.7 (297)	18.5 (8.4)	260	180
218442	214542	42	54	28.4 (721)	77.0 (1956)	26.5 (673)	15.8 (401)	14.4 (366)	23.3 (10.6)	315	225
218448	214548	48	60	28.4 (721)	77.0 (1956)	26.5 (673)	15.8 (401)	14.4 (366)	23.3 (10.6)	315	225
218457	214557	57	72	33.8 (859)	92.1 (2340)	31.7 (805)	19.8 (503)	18.4 (467)	26.0 (11.8)	370	270

# Temporary Overvoltage (TOV)

MOV type surge arresters are by nature voltage sensitive devices. At normal line-to-ground voltage, an arrester is energized at or below its MCOV and conducts very little power frequency current. Disturbances on the system can expose the arrester to higher power frequency voltage and thus higher current through the arrester. The power frequency voltage withstand capability of an arrester is best expressed graphically. The following two graphs depict the TOV capability versus time for Hubbell IEEE and IEC distribution class surge arresters. The Optima designs demonstrate enhanced TOV capability. Please refer to the appropriate type test report for each product line for additional details.

TOV Capability – IEEE Arresters (no prior duty)

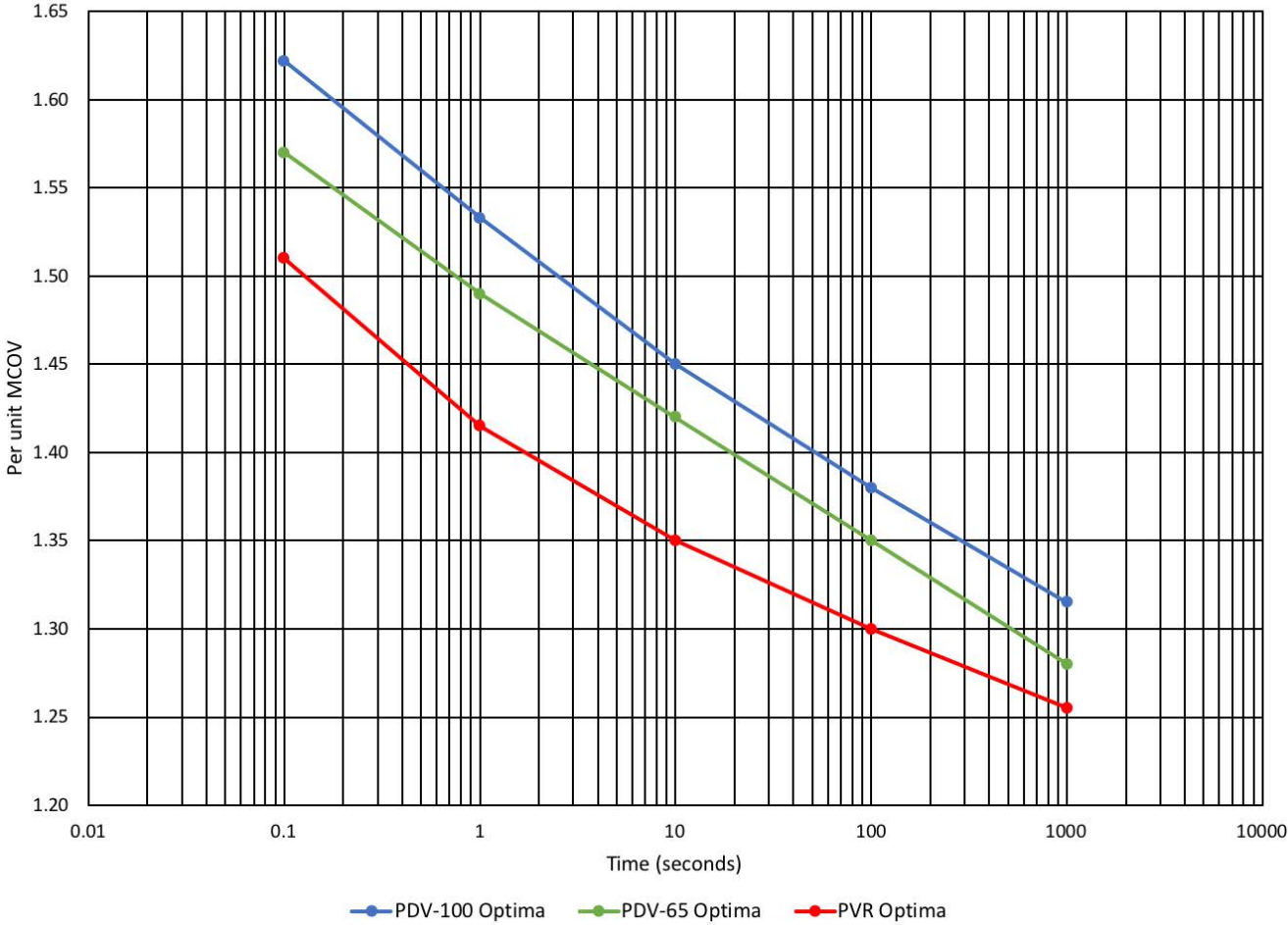

# Temporary Overvoltage (TOV)

## TOV Capability – IEC Arresters (no prior duty)

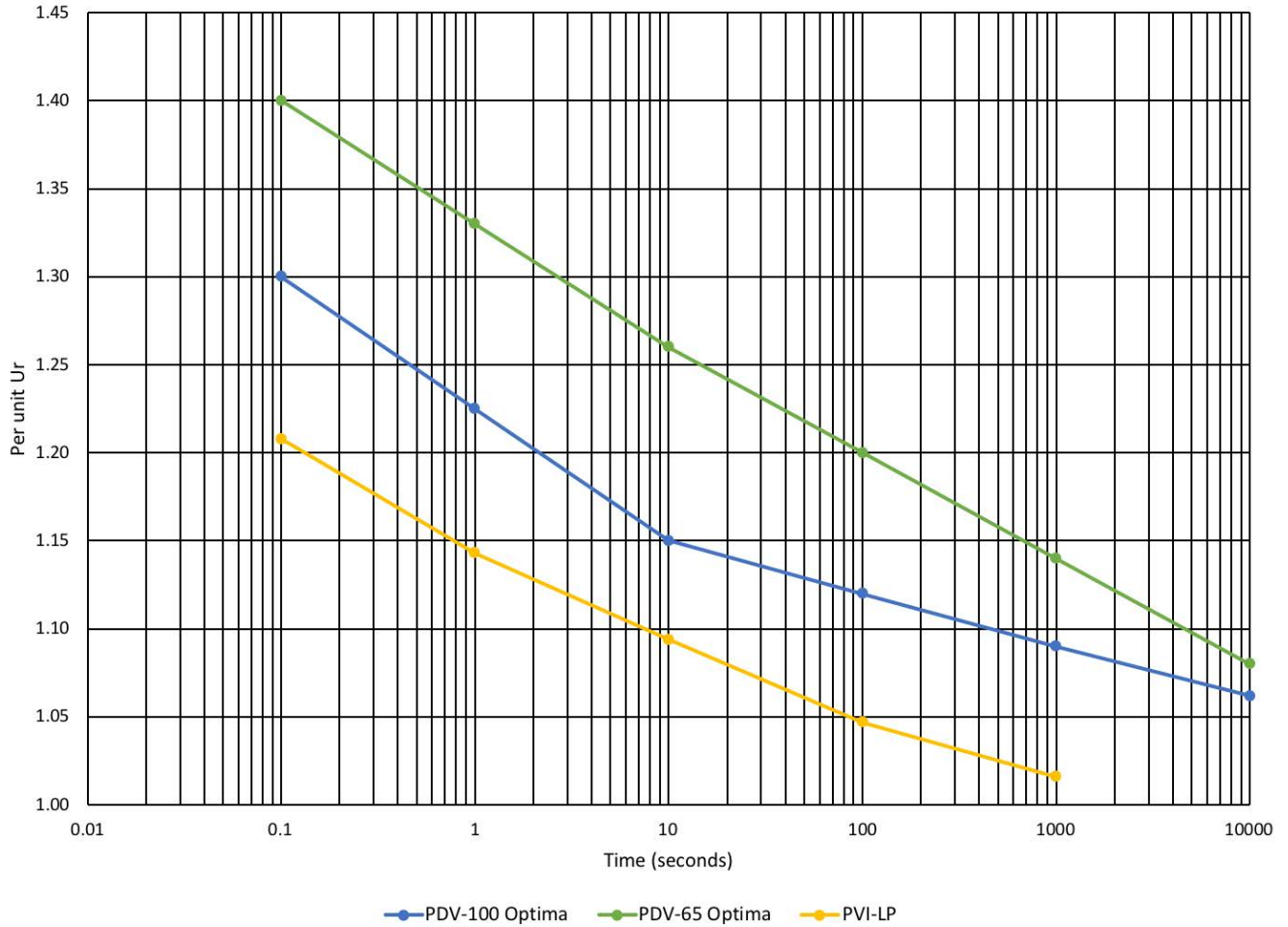

# Ground Lead Disconnecter

Distribution arresters are commonly supplied with a ground lead disconnecter (GLD). This accessory is provided to allow continued system operation in the rare event of an arrester short circuit. It additionally provides a visual indication that an arrester has disconnected to field personnel. This feature allows identification of equipment that is unprotected and ensures efficient use of personnel resources. The Hubbell GLD is a patented capacitive graded design which offers enhanced current sensitivity compared to conventional disconnectors. Additionally, other designs which are resistively graded tend to thermally fail during TOV or end of life events. This can impair successful disconnection of a shorted arrester and lead to outages and dissatisfied customers.

IEEE and IEC standards require a disconnecter operate at currents ranging from 20 to 800 Amps. The Hubbell design operates at currents as low as 1 Amp. It additionally prevents thermal runaway scenarios that may occur with resistive graded disconnectors.

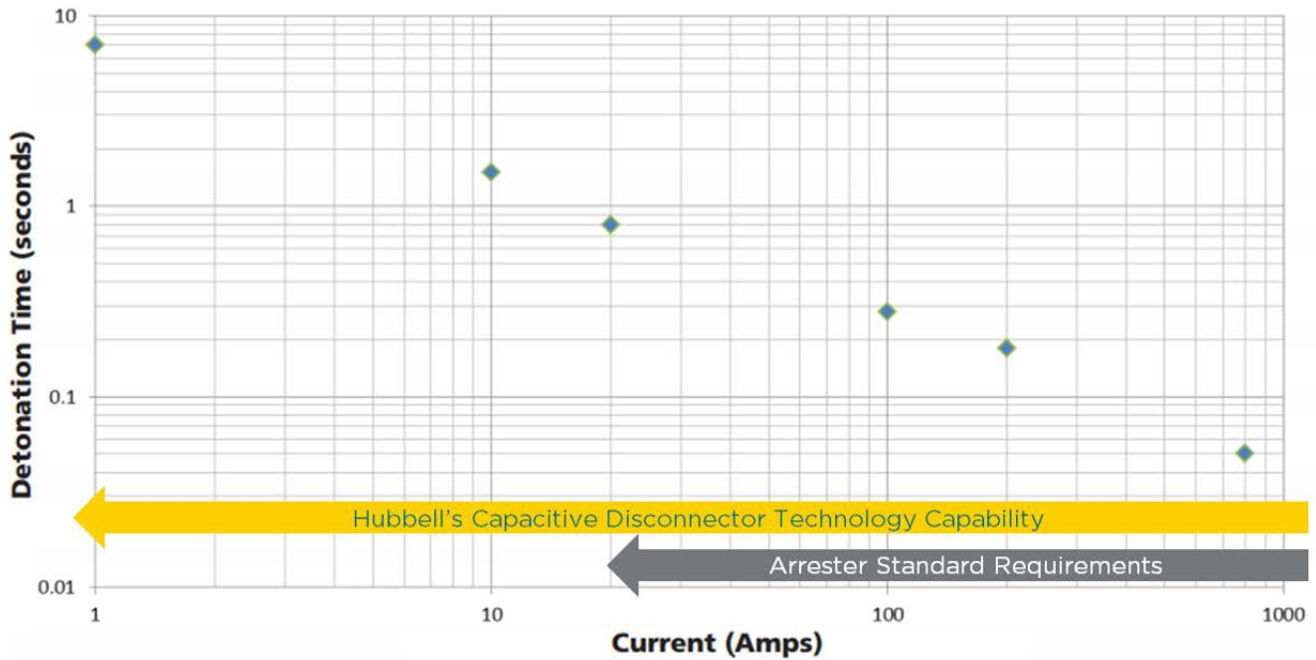



# Insulating Base Brackets

When specified distribution arresters come equipped with an insulating base bracket with integrated GLD. Each insulating bracket has unique electrical properties based on the system voltage where the associated arrester is applied. In the remote case of arrester short circuit, the insulating bracket must withstand system voltage until the shorted arrester can be replaced. This can be problematic in some locations, so Hubbell has developed a High Track Resistant (HTR) insulating bracket. This bracket is capable of withstanding system voltage indefinitely. The following table provides relevant characteristics for each insulating bracket.

Bracket Type	MCOV (kV)	Duty Cycle Voltage, Ur (kV)	Leakage Distance - in (mm)	BIL (kV)	Power Frequency Withstand (kV)	
					Dry	Wet
Short	2.55 - 10.2	3 - 12	4.37 (111)	75	40	30
Medium	12.7 - 19.5	15 - 24	7.24 (184)	80	45	35
Long	22 - 36	27 - 45	9.25 (235)	95	55	45
High Track Resistant	2.55 - 36	3 - 45	9.56 (243)	105	60	50

The figures below provide relevant physical dimensions for the various insulating brackets. Additional dimensions are specific based on the use of metric or imperial terminals. For other options and additional support please contact your Hubbell representative.

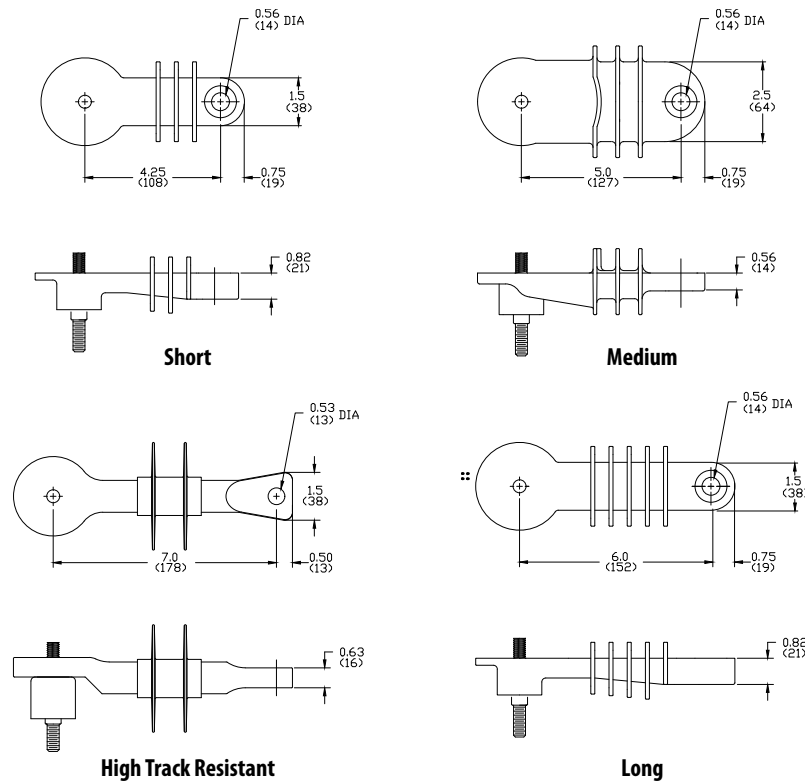

# Arrester Accessories

Hubbell offers a wide range of wildlife guards to shield energized arrester components from incidental wildlife contact. Common wildlife guards are shown in the following images. For other guard options and additional support please contact your Hubbell representative.

**Universal Optima Guard:  
Part Number 275120-4001**

The Optima wildlife guard is designed for single or through connection lead wires. Each side of the guard has webbed fingers that prevent accidental contact with the energized top of the arrester by wildlife. The universal Optima cap can be used with PDV-65 and PDV-100 Optima style surge arresters with imperial hardware.



**Arrester Guard:  
Part Number 273054-4002 (3/8" hardware) and  
Part Number 271813-4009 (M12 hardware)**

Additional standard arrester wildlife guards are shown for single or through connection lead wires. These guards can be used with all arrester products, depending on the use of imperial or metric hardware.



**Wildlife Protector Guard:  
Part Number PSPPD6CAPKIT1 (48" lead wire),  
Part Number PSPPD6CAPKIT2 (18" lead wire)**

This guard isolates all exposed or energized line end hardware from accidental wildlife contact. This cap is only available for use with standard imperial hardware.



# Arrester Accessories

Hubbell now offers a full suite of wildlife guards through the Reliaguard® brand. Reliaguard parts are designed to have a superior fit for the underlying equipment to prevent gaps in coverage which can lead to wildlife caused power outages. Reliaguard parts are made from a proprietary material known as Reliatanium™. Reliatanium is UV stable, track resistant, flame retardant and meets the testing requirements of the IEEE 1656 -2010 Guide.

The LA-13007 wildlife guard is specifically designed for arrester protection. This guard installs over the first shed of the arrester housing and prevents wildlife activity from taking place under the guard. It accommodates a wide range of conductor diameters and easily accommodates feed through conductors. Please contact your Hubbell representative for additional details on the LA-13007 guard and other Reliaguard product offerings.



## Reliaguard Multiport LA Guard Exclusive Features

### Three cable exits

Three cable exits allow easy vertical, right angle and feed-thru connections common on many lightning arresters.

### Overlapping fingers

Overlapping fingers are a critical feature for guards as they deter access and prevent animals from using the opening to a guard cavity as a place to store food or nesting materials.

### Glove-friendly loop latches

Reliaguard's loop latch design provides best in class security and allows easy operation by lineman wearing high-voltage gloves.

### Optional permanent closure

A feature that is optionally used by some utilities to permanently close the cover by applying a push fastener or tie wrap.

### Robust mechanical hinges

Strong hinges ensure the integrity of the guard is maintained in transport, installation or on re-application of the guard

### Made from Reliatanium™

Reliatanium is Reliaguard's own proprietary material formulation. It is UV stable, track resistant and flame retardant (won't burn or drip).

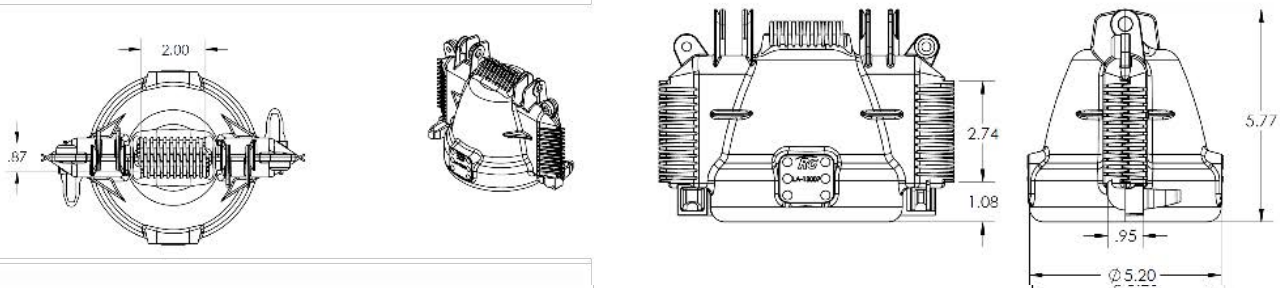

Product Name	Part Number	Height Dimension	Diameter Dimension	Additional Dimension	Pack Size (MOQ)
Lightning Arrester – Multiport (Loop Latch)	LA-13007	5.8 (147.3)	5 (127)	2.0 (50.8) base port	24

# Arrester Accessories

**Transformer Bracket Cover:**  
**Part Number PSPPD6COV**

The transformer bracket cover insulates the mounting bolt and a portion of the transformer mounting bracket. The bracket cover can be used with mounting bracket 273066-4004.

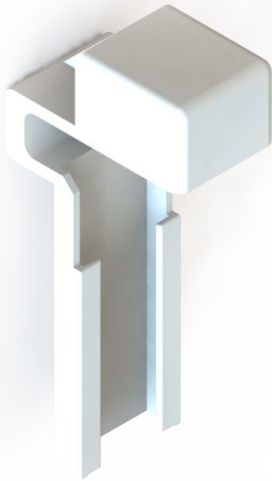

**Standard Mounting Brackets**

Dimensions for the common NEMA crossarm and transformer mounting brackets are shown in the figure below. Please contact Hubbell for additional options and support selecting a bracket for your application.

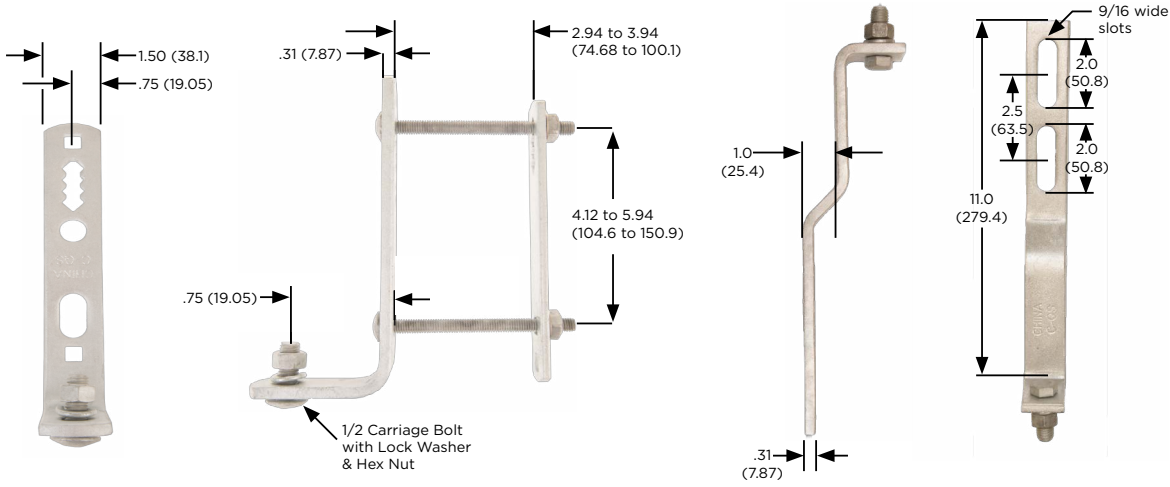

Dimensions: Inches (mm)

**Part Number 273456-3001**

Dimensions: Inches (mm)

**Part Number 273066-4004**



# Arrester Hardware – Imperial

Hubbell offers a standard series of distribution arresters with imperial hardware. The table below defines the various hardware configurations using the standard 7XXX hardware code. To select a hardware code for your application, start by choosing the top terminal hardware from Table A. Next choose the mounting or insulating bracket required for your application from Table B. Lastly the lower terminal hardware is identified in Table C. For other options please contact your Hubbell representative.

### TABLE A - Top Terminal Hardware

	<b>71XX</b> 3/8" Stud (No Option)	<b>72XX</b> Nut & Wire Clamp	<b>73XX</b> Protective Cap, Nut & Wire Clamp	<b>74XX</b> Nut, Wire Clamp & Protective Cap (One Hole) (PVR only)	<b>75XX</b> Nut, Wire Clamp, Protective Cap (One Slot) & 18" Wire Lead	<b>76XX</b> Flipper Fuse Assembly Nut & Wire Clamp	<b>77XX</b> Nut, Wire Clamp, 3-Piece Protective Cap
--	---	------------------------------------	--	--	--	---	--

### TABLE B - Mounting Hardware

<b>7X0X</b> No Bracket No Isolator	<b>7X1X</b> Insulated Base Bracket with Isolator	<b>7X2X</b> Insulated Base Bracket with Isolator & NEMA 4x5 X-Arm Bracket	<b>7X3X</b> Insulated Base Bracket with Isolator & Trans- former Bracket	<b>7X4X</b> Insulated Base Bracket with Isolator & NEMA Angle Bracket	<b>7X5X</b> Insulated Base Bracket with Isolator & NEMA 6x6 X-Arm Bracket	<b>7X6X</b> Metal Base Mounting Strap	<b>7X7X</b> Metal Base Mounting Strap & NEMA 4x5 X-Arm Bracket
--	---	---	--	---	---	---	--

### TABLE C - Lower Terminal Hardware

	<b>7XX1</b> 3/8" Stud (No Option)	<b>7XX2</b> Nut, Washers & Threaded Terminal Nut	<b>7XX3</b> Isolator Nut, Ground Strap Washer	<b>7XX4</b> Isolator Nut, Washer & Threaded Terminal Nut	<b>7XX5</b> Isolator Nut, Protective Cap (2-Slot), Washer & Threaded Terminal Nut	<b>7XX6</b> Ground Strap, Nut, Washers & Threaded Terminal Nut	<b>7XX7</b> Nut, Washers & Threaded Terminal Nut
--	---	---	--	--	--	--	---

\* Must be ordered in conjunction with codes 7000, 7060 or 7070

### Common Imperial Hardware Options

Hardware Suffix	Top Terminal Hardware	Mounting Hardware	Lower Terminal Hardware
7202	Hex Nut & Wire Clamp	No Hardware	Hex Nut, Flat Washer & Wire Clamp
7214	Hex Nut & Wire Clamp	No Hardware	Hex Nut, Flat Washer & Wire Clamp
7314	Hex Nut, Wire Clamp & Protective Cap	No Hardware	Hex Nut, Flat Washer & Wire Clamp
7224	Hex Nut & Wire Clamp	NEMA 4x5 Crossarm Bracket	Hex Nut, Flat Washer & Wire Clamp
7324	Hex Nut, Wire Clamp & Protective Cap	NEMA 4x5 Crossarm Bracket	Hex Nut, Flat Washer & Wire Clamp
7333	Hex Nut, Wire Clamp & Protective Cap	Transformer Bracket	Hex Nut, Copper Ground Strap & Flat Washer
7514	Hex Nut, Wire Clamp, Protective Cap & 18" Lead Wire	No Hardware	Hex Nut, Flat Washer & Wire Clamp
7533	Hex Nut, Wire Clamp, Protective Cap & 18" Lead Wire	Transformer Bracket	Hex Nut, Copper Ground Strap & Flat Washer

# Arrester Hardware – Metric

Hubbell additionally offers a standard series of distribution arresters with metric hardware. All designs include M12 hardware with a standard threaded stud length of 45 mm (1.77"). The table below defines the various hardware configurations. All metric hardware configurations start with a C suffix to define the M12 45 mm long top terminal. To select a hardware code for your application, start by choosing the insulating bracket required for your application from Table A. Next choose the top terminal hardware from Table B. Lastly choose the lower terminal hardware from Table C. For other options please contact your Hubbell representative.

**TABLE A -Digit 8: Insulating Bracket with Disconnecter**

<b>CCXX</b>	<b>C4XX</b>	<b>C7XX</b>	<b>C2XX</b>	<b>C3XX</b>	<b>C5XX</b>
45mm Long Bottom Terminal	Short Insulating Base Bracket with Disconnecter	Medium Insulating Base Bracket with Disconnecter	Long Insulating Base Bracket with Disconnecter	High Track Resistant Insulating Base Bracket with Disconnecter	Disconnecter without Insulating Bracket

**TABLE B - Digit 9: Top Terminal Hardware**

<b>CXAX</b>	<b>CXBX</b>	<b>CXCX</b>	<b>CXFX</b>	<b>CXJX</b>	<b>CXXX</b>
No Hardware	Wire Clamp & Hex Nut	Wire Clamp, Hex Nut & Protective Cap	Lock Washer & (2) Hex Nuts	Lock Washer, Flat Washer, Hex Nut & Protective Cap	(2) Wire Clamps, Lock Washer & Hex Nut

**TABLE C -Lower Terminal Hardware**

<b>CXXA</b>	<b>CXXB</b>	<b>CXXC</b>	<b>CXXE</b>	<b>CXXJ</b>	<b>CXXP</b>
No Hardware	Ground Strap, Washer & Hex Nut	Wire Clamp, Washer & Hex Nut	(2) Washers, Wire Clamp & Hex Nut	Washer, Wire Clamp, Hex Nut & 18" Ground Lead	Lock Washer, Flat Washer, Hex Nut & 6 x 6 NEMA Bracket

**Common Metric Hardware Options**

<b>Hardware Suffix</b>	<b>Top Terminal Hardware</b>	<b>Mounting Hardware</b>	<b>Lower Terminal Hardware</b>
CAA	No Hardware	No Hardware	No Hardware
CCBE	Wire Clamp & Hex Nut	No Hardware	(2) Washers, Wire Clamp & Hex Nut
C4BC	Wire Clamp & Hex Nut	No Hardware	Wire Clamp, Washer & Hex Nut
C7CC	Wire Clamp, Hex Nut & Protective Cap	No Hardware	Wire Clamp, Washer & Hex Nut
C2BC	Wire Clamp & Hex Nut	No Hardware	Wire Clamp, Washer & Hex Nut
C2CC	Wire Clamp, Hex Nut & Protective Cap	No Hardware	Wire Clamp, Washer & Hex Nut



# Arrester Selection

Protecting your vital assets begins with selecting the proper Hubbell distribution surge arrester. Three facets are generally considered to select a product appropriate for your application. Use these steps to select the appropriate arrester for your application.

## Step 1: Select the arrester classification

Hubbell offers a full range of IEEE and IEC classified arresters to meet your system requirements. Start by selecting the appropriate arrester class.

IEEE Classes	IEC Classes
Normal Duty (ND)	Distribution Medium (DM)
Heavy Duty (HD)	Distribution High (DH)
Heavy Duty (HD) Riser	-
Intermediate	Station Low (SL)

## Step 2: Select the arrester MCOV (Uc)

Selection of an arrester is based upon the maximum continuous operating voltage (MCOV or Uc) that is applied across the arrester in service (line-to-ground). Common arrester MCOV values are provided in the following table. Additional guidance for different system grounding is provided in the Arrester Selection Guidelines section.

2.55	5.1	7.65	8.4	10.2	12.7	15.3
17	19.5	22	24.4	29	31.5	34

\*Additional ratings may be available depending on the arrester class

## Step 3: Select mounting hardware and accessories

Mounting hardware and accessories are unique for each application. Select options are detailed on the Arrester Hardware pages. Additional options are available. Please contact your Hubbell representative for additional support with your application.

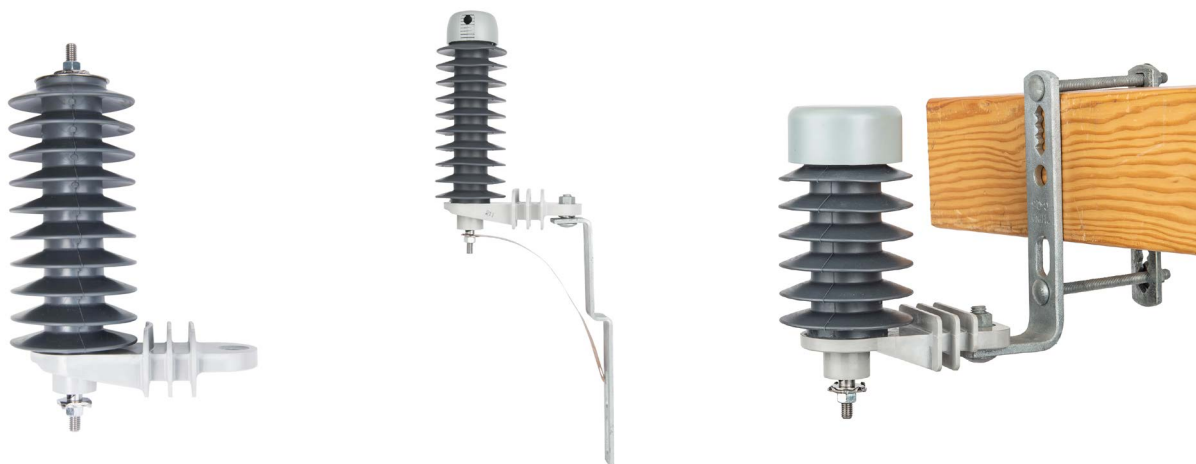

# Ordering

Hubbell distribution arresters are specified using a 10-character part number. The first four digits characterize the arrester type or classification. The fifth and six characters identify the arrester voltage. The next four characters define the arrester accessories, hardware and optional mounting brackets. Additional characters may be used to define special requirements based on the application.

An example is given below to select a distribution arrester catalog number for both imperial and metric hardware arresters. Please contact your Hubbell representative for additional support with your application.

## Imperial Hardware:

To select an 8.4 kV MCOV Heavy Duty type arrester the base prefix would be 213709. Next, hardware will be defined. A common option includes a wildlife guard, insulating base bracket with integrated ground lead disconnecter and standard hardware. The corresponding imperial hardware code is 7314.

213709-7314



## Metric Hardware:

To select a 15.3 kV Uc Distribution High type arrester the base prefix would be 294215. Next, hardware will be defined. A common option includes an insulating base bracket with integrated ground lead disconnecter and standard hardware. The corresponding metric hardware code is C7BC.

294215-C7BC





# Routine Testing

Hubbell performs routine acceptance testing on 100% of arresters manufactured. Testing is done in accordance with IEEE C62.11 and IEC 60099-4 surge arrester standards. Additional testing is performed in accordance with internal Hubbell design specifications. If required, please contact your Hubbell representative for a copy of the routine arrester test certification.

After assembly, the arresters are 100% tested as follows:

## Residual (Discharge) Voltage:

Determined by the sum of the MOV elements, each arrester is certified to be within a manufacturer specified range that aligns with the arrester's published ratings.

## Reference Voltage:

The voltage at which the arrester conducts the reference current per the table below. This test verifies the proper MOV blocks were used in the assembly.

PDV-65 Optima	3 mA
PDV-100 Optima	4 mA
PVR Optima	5 mA
PVI-LP	7 mA

## Partial Discharge (PD):

Power-frequency voltage is raised to the duty cycle voltage rating of the arrester, held for not less than 2s, and then lowered to 1.05 times the MCOV of the arrester. The measured PD shall not exceed 10 pC.

## Power Frequency (PF):

A minimum voltage of 1.25 times the MCOV of the arrester is applied to verify that the measured values of watts loss does not exceed the arrester or unit's specified limits.

# Mechanical Capability

Distribution arresters rarely see mechanical loading outside of forces exerted during installation or sporadic wind gusts. Each Hubbell product line has distinct mechanical capabilities based on IEEE and IEC standards, as well as Hubbell internal specifications. The following values are conservative in nature and are in excess of common application requirements.

Product Line	Maximum Design Cantilever Load (MDCL) - in-lbs (Nm)	Specified Long Term Load (SLL) - in-lbs (Nm)	Specified Short Term Load (SSL) - in-lbs (Nm)	Tension - lbf (kN)	Torsion - in-lbs (Nm)	Compression - lbf (kN)
PDV-65 Optima	300 (34)	300 (34)	600 (68)	562 (2.5)	239 (27)	562 (2.5)
PDV-100 Optima	700 (79)	700 (79)	1200 (135)	562 (2.5)	239 (27)	562 (2.5)
PVR Optima	1200 (135)	-	-	562 (2.5)	478 (54)	562 (2.5)
PVI-LP	1130 (128)	1130 (128)	2260 (256)	562 (2.5)	478 (54)	562 (2.5)

\*MDCL confirmed by IEEE C62.11, SLL/SSL confirmed by IEC 60099-4

# Arrester FAQ's

## 1. What tightening torque should be used for arrester hardware?

Recommended tightening torques for arrester hardware are shown in the table below.

Stud Size	Maximum Recommended Tightening Torque
3/8"	20 ft-lb (27 Nm)
1/2" (M12)	40 ft-lb (54 Nm)

## 2. What does MCOV, COV or UC value of a surge arrester mean?

MCOV stands for the Maximum Continuous Operating Voltage. COV or UC, stands for Continuous Operating Voltage. This value represents the power frequency voltage that may be continuously applied to a surge arrester.

The MCOV / Uc is selected for a given system voltage based on the maximum line-to-line voltage. The system grounding parameters can additionally influence the selection. Hubbell representatives can assist with the proper MCOV selection for your specific application.

## 3. How does MCOV differ from the Duty Cycle rating?

The Duty Cycle rating of a surge arrester is a legacy term which holds no value in the selection of a surge arrester. Historically, the Duty Cycle rating was the power frequency voltage at which the arrester can successfully pass the Duty Cycle test per IEEE Standard C62.11. The Duty Cycle test was removed in the 2020 edition of IEEE C62.11.

The Ur of a surge arrester is a short-term TOV (Temporary Over Voltage) rating.

## 4. What routine maintenance does Hubbell Power Systems recommend for distribution arresters?

Hubbell Power Systems does not recommend any particular maintenance plan for surge arresters. Hubbell surge arresters are designed to provide years of excellent service with no routine maintenance.

## 5. What field testing does Hubbell Power Systems recommend for distribution arresters?

Hubbell arresters do not require field testing. Properly designed, assembled, selected and applied arresters from reputable manufacturers should be essentially immune to degradation. If desired, the most commonly performed field test to evaluate the health of an arrester is infrared analysis. It is used to determine if the arrester shows a long-term trend of increasing heat buildup, which may indicate replacement is needed. Please contact your Hubbell representative for additional guidance on arrester field testing.

## 6. What size lead wire is recommended for the line and ground connection?

Hubbell arresters use a standard #6 lead wire on the line side of an arrester. For transformer mounted designs a copper strap is used for the ground connection. Additional wire and strap offerings are available depending on applications requirements. In any case the lead wire should not be excessively long or taught. A taught lead wire can impair disconnect operation or negatively impact the arrester protective level.

The diameter of the lead connected to the arrester has insignificant effect on the protection offered by the arrester. However, the length can produce an inductive voltage drop which will negatively influence the residual voltage of the arrester. IEC standard design testing is completed with lead wires of 5 mm in diameter, which is slightly smaller than a #4 lead wire.



# Arrester FAQ's

## 7. What size wires can be attached using the standard wire clamp?

Hubbell arrester terminals are clamp type and suitable for industry standard wire sizes from No. 6 AWG solid to No. 2 AWG stranded, which are metric sizes 16mm<sup>2</sup> to 35 mm<sup>2</sup>.

## 8. Are there any restrictions on how to attach the ground lead connection?

The ground lead disconnecter (GLD) needs to be able to completely separate from the arrester in the remote event of failure. Disconnecting allows the feeder to be re-energized and provides visual indication of the failure location.

## 9. What information is included on the arrester nameplate?

IEEE C62.11 and IEC 60099-4 require minimum information be included on the nameplate of each surge arrester. An example nameplate is shown below. Additional nameplates are used based on requirements and requests.

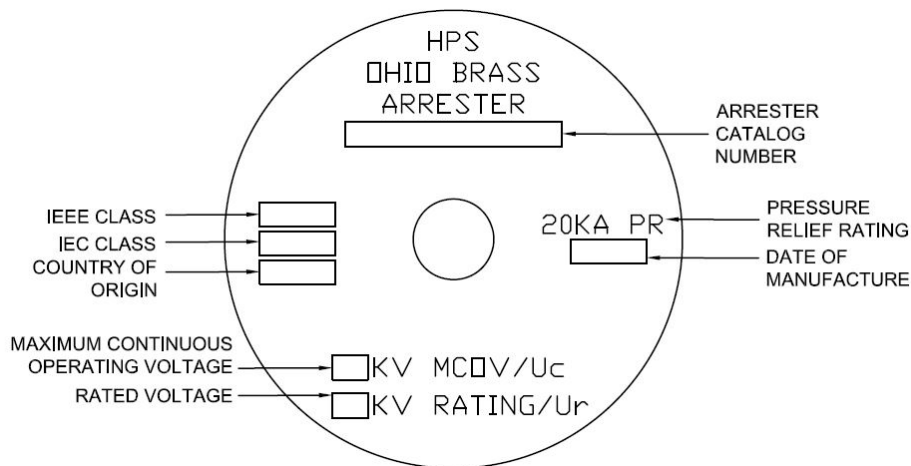

## 10. What if the arrester does not have the minimum creepage distance needed for my application?

Hubbell offers high creep arrester distances based on application requirements. Please contact your Hubbell representative for additional support.

## 11. I have a question that is not covered in this section.

For additional support please contact Hubbell representative or submit a request via the Hubbell website.

# Technical Terms

**BIL (Basic Lightning Impulse Insulation Level):** The electrical strength of insulation in terms of the crest value of a standard lightning impulse under standard atmospheric conditions. Equipment BIL is compared against the arrester residual voltage to determine the margin of protection.

**Creepage Distance:** The distance between the line and ground terminals of an arrester drawn along the outside of the housing. Also referred to as leakage distance.

**Crest Value:** The maximum value that a wave, surge or impulse attains.

**Design (Type) Tests:** Tests made on each arrester family or design to establish performance characteristics and to demonstrate compliance with the appropriate industry standards. Once made, they need not be repeated unless the design is changed, so as to modify performance.

**Discharge Voltage:** The voltage that appears across the terminals of an arrester during passage of discharge current. Also referred to as residual voltage.

**Fault Current:** The current from the connected power system that flows in a short circuit.

**Ground Terminal:** The conducting part provided for connecting the arrester to ground.

**Line Terminal:** The conducting part of an arrester provided for connecting the arrester to the circuit conductor.

**MOV (Metal Oxide Varistor):** The power semi-conductor that limits the surge voltage allowing the arrester to perform its protection function. This is the electrically active component of the surge arrester.

**MCOV (Maximum Continuous Operating Voltage):** The maximum designated root-mean-square (rms) value of power-frequency voltage that may be applied continuously between the terminals of the arrester.

**Partial Discharge (PD):** A localized electric discharge resulting from ionization in an insulation system when the voltage stress exceeds critical value. The discharge partially bridges the insulation between electrodes.

**Phase-to-Ground clearance:** The phase to ground spacing required between metal parts at 1800m in order to prevent flashover.

**Phase-to-Phase clearance:** The phase to phase spacing required between metal parts at 1800m in order to prevent flash over.

**Reference Current (Iref):** The peak value of the resistive component of a power-frequency current high enough to make the effects of stray capacitance of the arrester negligible.

**Reference Voltage (Vref):** The lowest peak value independent of polarity of power-frequency voltage, divided by the square root of 2, required to produce a resistive component of current equal to the reference current of the arrester.

**Routine Tests:** Tests made by the manufacturer on every device to verify that the product meets the design specifications. Some tests are required by IEEE and IEC standards, while other tests are dictated by Hubbell Engineering.



# Technical Terms

**Steep front:** A nominal discharge current impulse with a front time of 0.5 microseconds. Also referred to as front-of-wave (FOW)

**Strike distance:** The distance in air of a line between two conductors on the arrester.

**Switching Surge:** The surge current when a system changes configuration.

**TOV (Temporary Over Voltage):** A power frequency (48 – 62 Hz) voltage in excess of normal line-to-ground voltage. A TOV is typically system generated. The magnitude and duration are a function of the power system parameters.

**$U_c$ :** The designated root-mean-square (rms) value of power-frequency voltage that may be applied continuously between the terminals of the arrester.

**Watts Loss:** Power loss through an arrester while energized. Routine tests are conducted at 1.25 x MCOV.

**Wet Withstand:** Maximum power frequency voltage that the arrester can withstand in wet conditions without causing an external flashover of the housing.

Reliability

NOTE: Because Hubbell has a policy of continuous product improvement, we reserve the right to change design and specifications without notice.

©Copyright 2022 Hubbell Incorporated

CA\_01\_065\_E

